

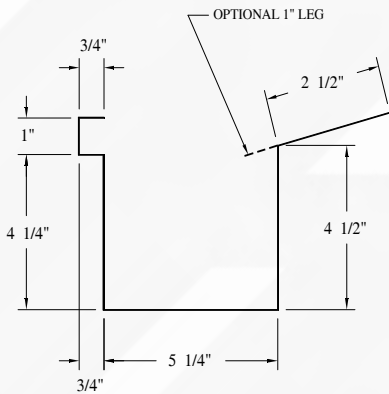

TRIM PROFILES

BOX GUTTER - EG1



SCULPTURED GUTTER - EG2

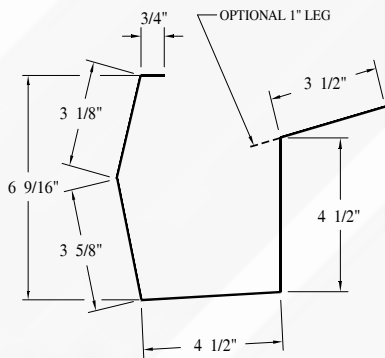

DRIP TRM - DT21

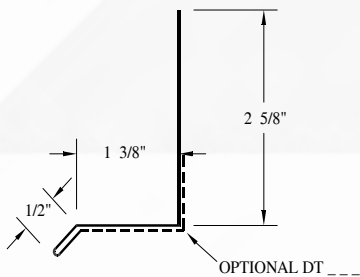

BOX RAKE TRIM - RT1

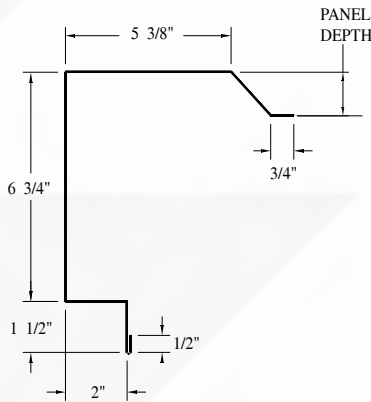

SCULPTURED RAKE TRIM - RT2

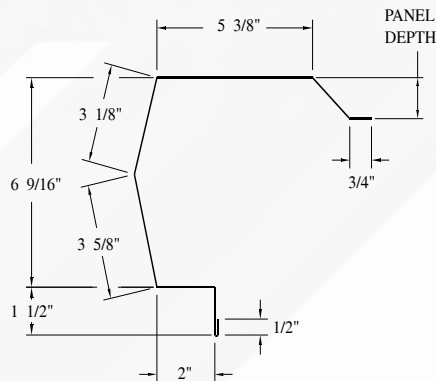

SILL TRIM - ST20

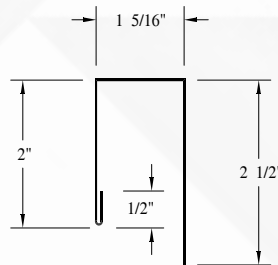

JAMB TRIM - JT17

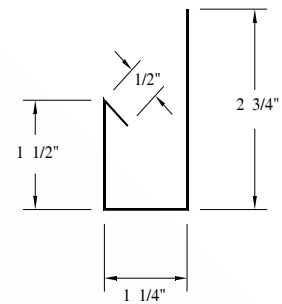

HEAD TRIM - HT18

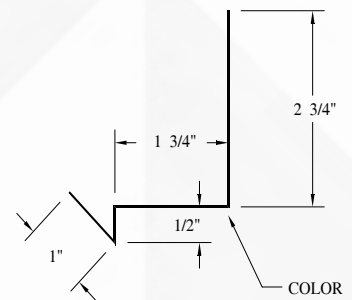

HEAD TRIM - HT19

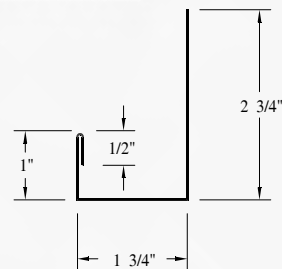



TRIM PROFILES

SCULPTURED EAVE TRIM - ET3

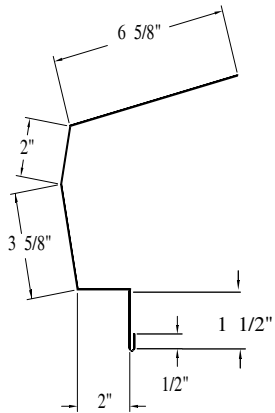

HIGH SIDE EAVE TRIM - ET4

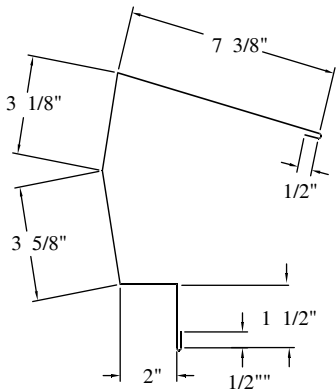

SIMPLE EAVE TRIM - ET5

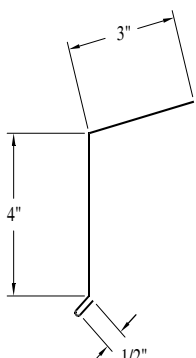

CORNER TRIM "R" PANEL - CT6

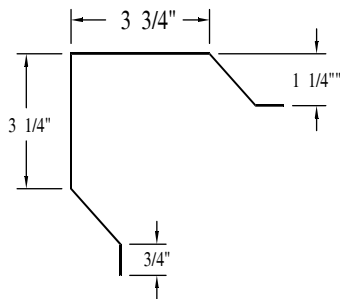

CORNER TRIM "U" PANEL - CT7

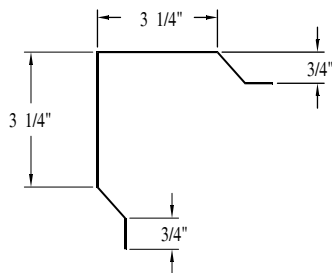

INSIDE CORNER "R" PANEL - CT8

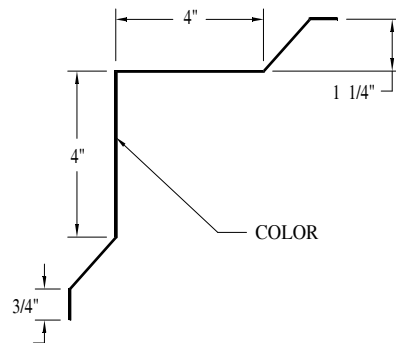

STARTER TRIM "A" PANEL - ST26

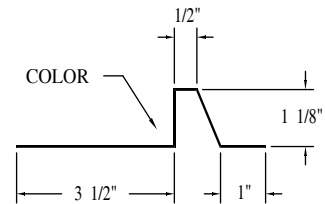

TRANSITION TRIM - TT27

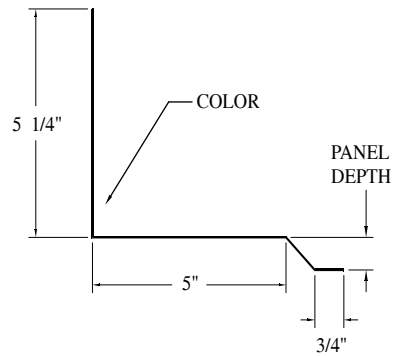

INSIDE CORNER "U" PANEL - CT9

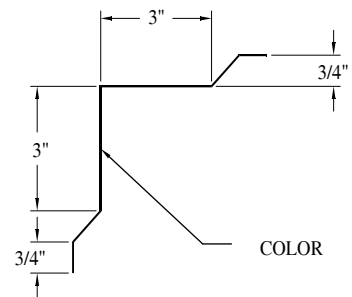



TRIM PROFILES

<p>PEAK BOXES</p>	<p>DOWNSPOUT OUTLET-DS14</p>	<p>RIDGE CAP -RC22</p>
<p>CORNER BOXES</p>	<p>DOWNSPOUT ELBOW 45°- DS15</p>	<p>RIDGE CAP - RC23</p>
<p>DOWNSPOUT (STRAIGHT) DS12</p>	<p>DOWNSPOUT OFFSET - DS16</p>	<p>VALLEY FLASHING - SV25</p>
<p>DOWNSPOUT (WITH KICKOUT) -DS13</p>	<p>SOFFIT/VALLEY FLASHING - SV24</p>	<p>CAP TRIM - CT26</p>